



# **E-paper Display Evaluation Kit for ESP32**

**ESP32-L(C579)**

Dalian Good Display Co., Ltd.



# Product Specifications

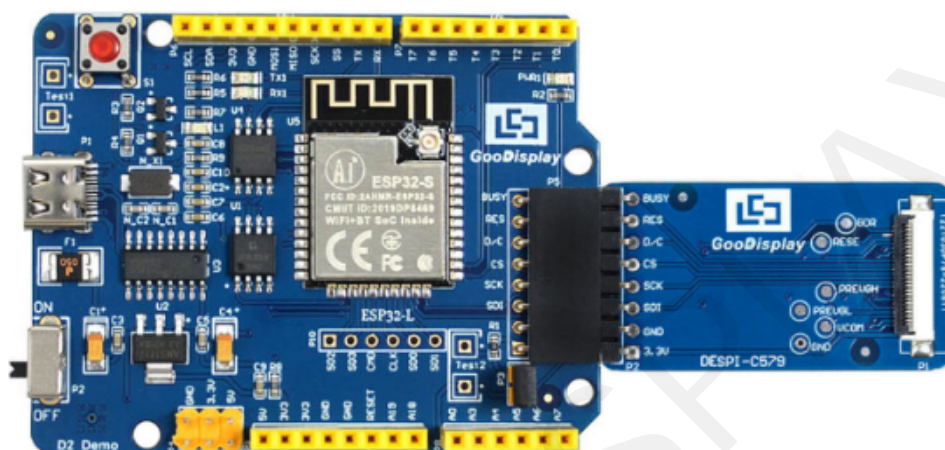

<b>Customer</b>	<b>Standard</b>
<b>Description</b>	<b>Evaluation Kit For E-paper Display</b>
<b>Model Name</b>	<b>ESP32-L(C579)</b>
<b>Date</b>	<b>2022/11/03</b>
<b>Revision</b>	<b>1.0</b>

	Design Engineering		
	Approval	Check	Design
			

Zhongnan Building, No.18, Zhonghua West ST,Ganjingzi DST,Dalian,CHINA

Tel: +86-411-84619565

Email: info@good-display.com

Website: www.good-display.com

---

## Contents

1. Overview .....	4
2. Mechanical Specifications .....	4
3. Diagram .....	5
4. Connection Mode and RESE Selection.....	7
5. Program Downloading .....	9

GOOD DISPLAY

## 1. Overview

The ESP32-L (C579) development kit is used on the Arduino IDE platform. This development kit is specially designed for 5.79 inch black and white monochrome E-paper display GDEY0579T93 and black, white and red three color E-paper display GDEY0579Z90. It can help developers better and faster to develop their E-paper display projects.

The ESP32-L (C579) development kit includes the main board ESP32-L and the adapter DESPI-C579.

The ESP32-L (C579) development kit only provides the basic function to drive the E-paper display while other functions such as WIFI need to be developed by users themselves.

## 2. Structure Specification

Parameter	Specification
Model	ESP32-L (C579)
Platform	Arduino
Dimension	Mother Board: 70mm x 54mm (ESP32-L) Adapter: 41mm x 22mm (DESPI-C579)
Power Interface	Type-C
Example Code	Available
Operating Temp.	-20°C~70°C(-4°F~158°F )
Main Function	Learn to drive E-paper display; Test and evaluate e-paper display; Support secondary development
Additional Function	Type-C, LED indicator, Reset button, Font chip, Flash chip, Current detection

### 3. Diagram

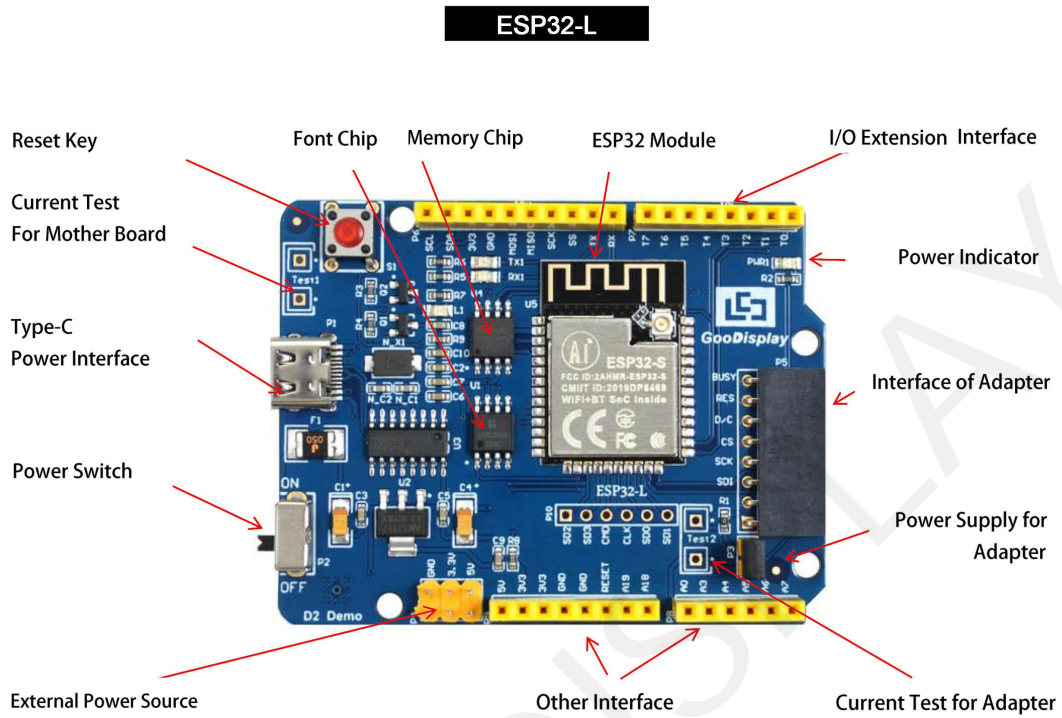

Figure 1 : ESP32-L

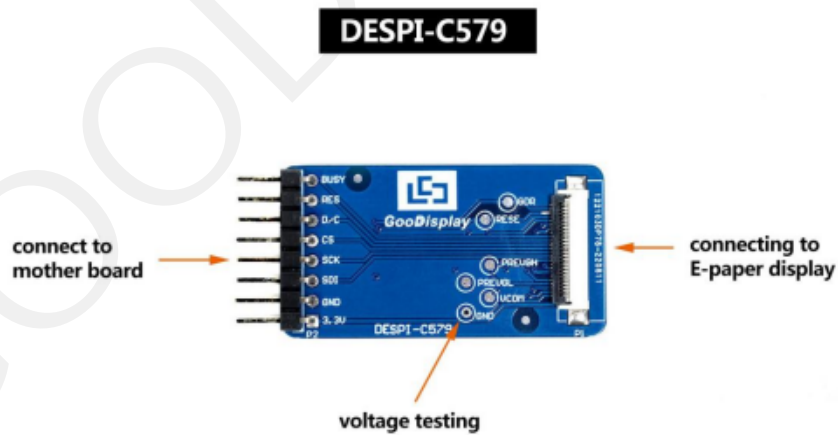

Figure 2 : DESPI-C579

### **3.1 Power Supply**

The input voltage is DC5V, which is powered by the Type-C interface.

### **3.2 USB to serial port transmission**

This development board uses USB to serial port communication. Users should install CH340 driver on computer before downloading program.

### **3.3 P3 short-circuit jumper**

P3 short-circuit jumper controls DESPI-C579's power supply, which is e-paper's power supply. Be sure to short it when using.

### **3.4 Current measurement**

The development kit supports current measurement of motherboard ESP32-L and DESPI-C579.

- 1) motherboard ESP32-L: Power off and make series connection between ampere meter and TEST1.
- 2) DESPI-C579: Power on and take off the short-circuit jumper P3, then make series connection between ampere meter and TEST2. Put on the short-circuit jumper P3 after measurement.

### **3.5 I/O port extension**

This development board led out the digital D0~D12 and the analog AO for development.

### **3.6 LED indicator light**

There is a indicator light reserved for developing.

### **3.7 Reset key**

This development board contains a reset key for users operation.

### **3.8 Expanded Functions**

Built-in Chinese font chip GT30L32S4W.

Built-in data storage chip W25Q16.

## 4. Connection Mode and RESE Selection

### 4.1 Connection between e-paper display and development board

Connect DESPI-C579 to ESP32-L for EPD as shown in Figure 3. Connect FPC to DESPI-C579 as shown in Figure 4. (Please note the direction of the e-paper display.)

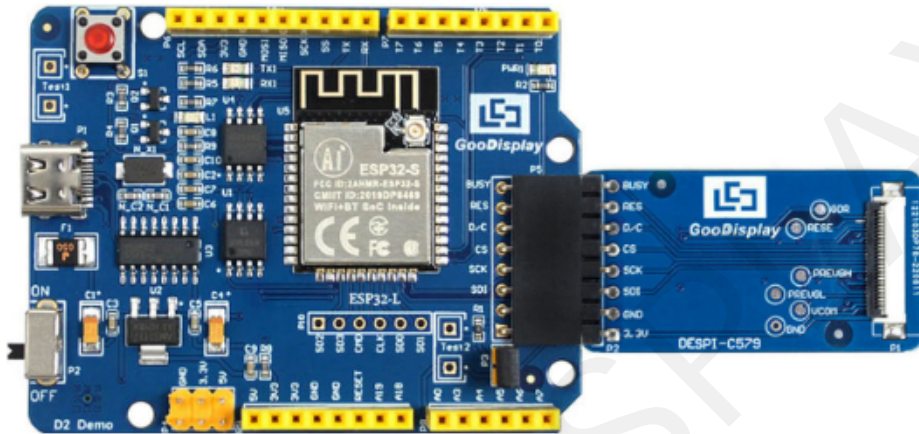

Figure 3 : Connection between ESP32-L for EPD and DESPI-C579

### 4.2 Connection between e-paper display and adapter board

1) Identify the front and back sides of the e-paper display, and insert the e-paper display into the adapter plate with the front side facing up

Note: The mirror side of the e-paper display is facing down and the display side is facing up.



Figure 4.1 Schematic diagram of e-paper display and adapter board plugging

2) Insert the FPC gold finger upward into the P1 connector of the adapterboard as shown in Figure 4.2.

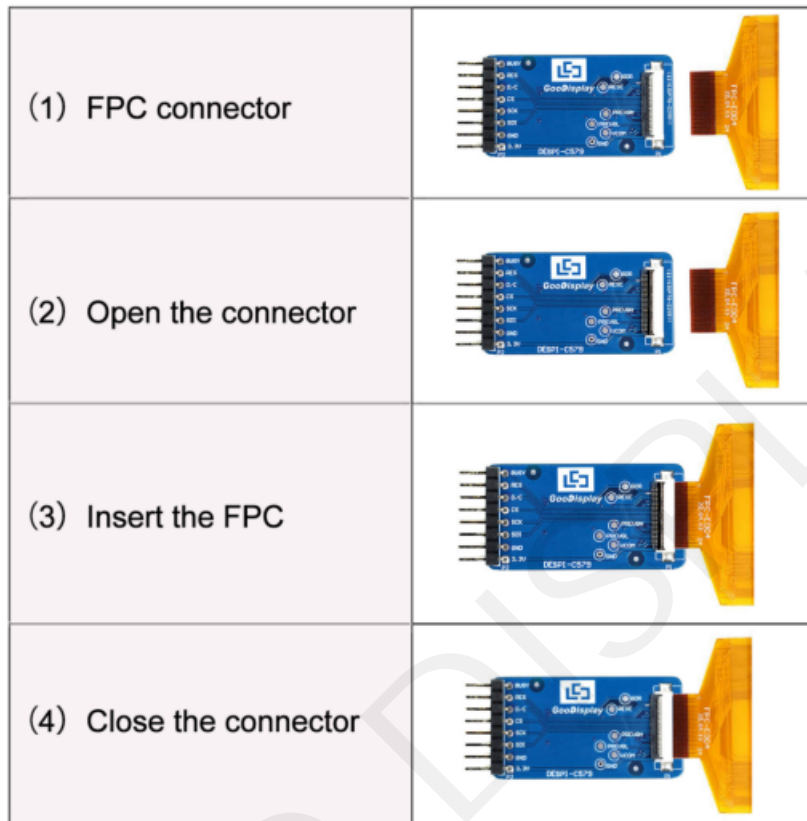

Figure 4.2 : Connection between DESPI-C579 and e-paper display



## 5. Program Downloading

This development board adopts serial port to download programs, which requires Arduino programming software, type-C cable, CH340 driver and esp32\_package\_v1\_0\_2 firmware package and python-2.7.17 plug-in. The operation steps are as follows:

1. For the first download, install CH340 driver and ESP32 on the computer\_package\_v1\_0\_2 firmware package, python-2.7.17 plug-in.

Firmware package: esp32\_package\_v1\_0\_2. The unzipped file name is espressif. Unzip the espressif folder and put it in the arduino/hardware directory. During installation, the Arduino programming software must be closed, and the firmware package can also be searched directly in the Arduino library manager.

Use the default installation path for CH340 driver and python-2.7.17 plug-in.

Run the program file get.exe in esp32/tools(you must have installed the python plug-in), as shown in Figure 5.

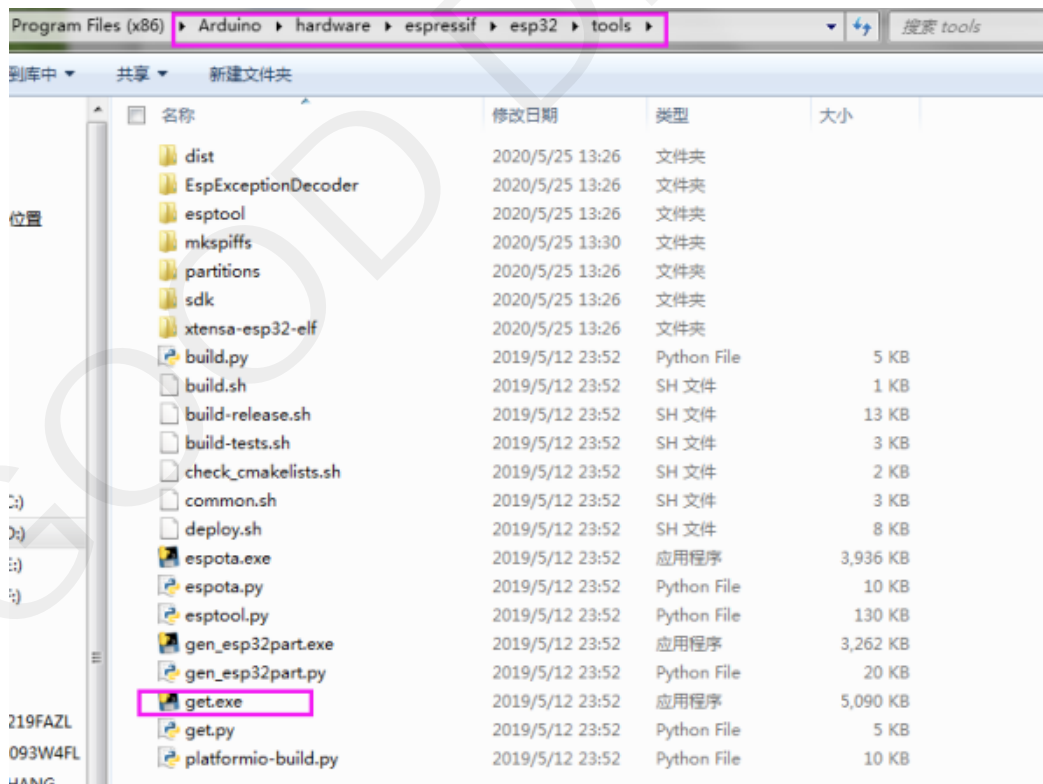

Figure 5 Run get.exe

2. Connect the Type-C interface of the development board to the computer with USB cable.
3. Open Arduino in the driver folder shown in Figure 6 with Arduino 1.8.6 ino engineering document.

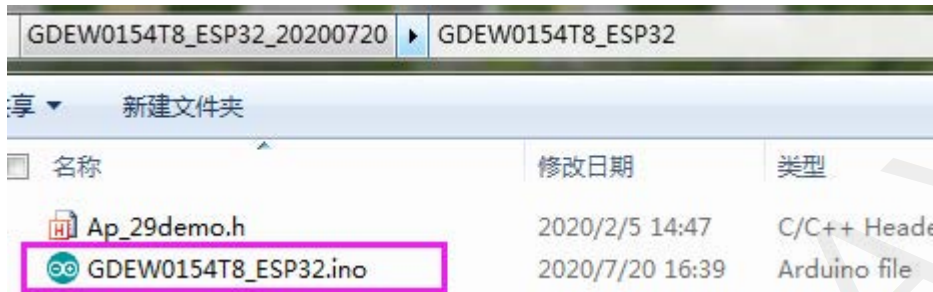

Figure 6 : Open Arduino.ino

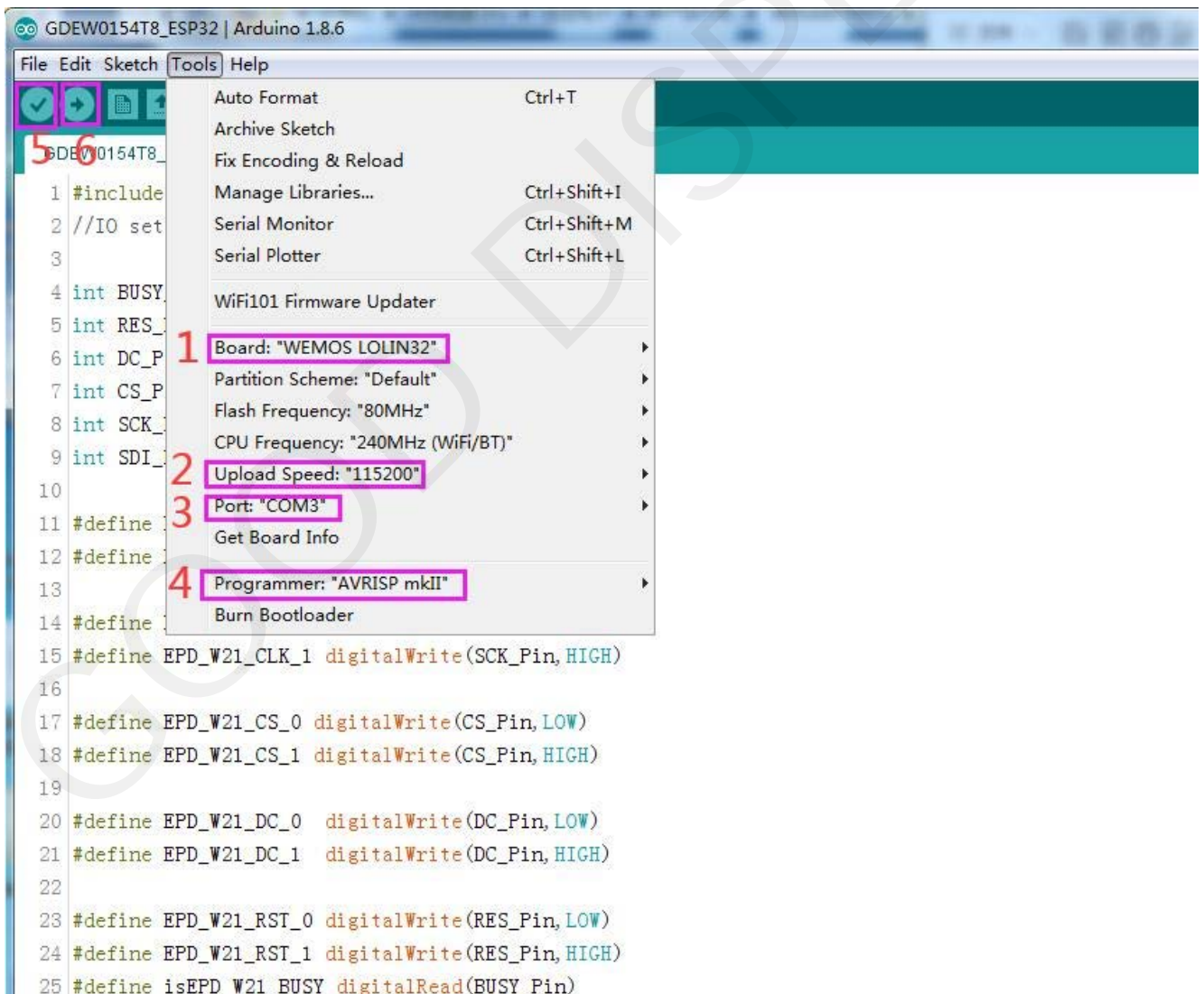



Figure 7 : Steps of downloading program

4. Set in "tools".
5. Click position 1 to select the development board model "WEMOS LOLIN32".
6. Click position 2 to select serial port baud rate "115200".
7. Click position 3 to select COM port.
8. Click position 4 to select the programmer model, and here select "AVRISP mkII".
9. Click position 5  to compile the program.
10. Click position 6  to download the program to the development board.
11. After the downloading, first power off the development board, connect the electronic paper display screen to the adapter board, and then power on again so that screen can display normally.

Note: if the compiler prompts "invalid library found" during program compilation, please ignore this prompt, which will not affect the actual program download.